

HOW TO BUILD AN ENERGY EFFICIENT HOUSE?

A PRACTICAL GUIDE FOR RURAL MASTERS



geres

HOW TO BUILD AN ENERGY EFFICIENT HOUSE?

A PRACTICAL GUIDE FOR RURAL MASTERS



SUMMARY



INTRODUCTION.....	5
ENERGY EFFICIENT HOUSE?.....	6
GENERAL PRINCIPLES.....	7

PASSIVE SOLAR DESIGN

COLLECTION OF SOLAR RADIATIONS.....	8
HOW TO DEFINE THE SOUTH?.....	12
COMPACTNESS.....	14
ROOM LAYOUT.....	15
DIRECT GAIN.....	16
INDIRECT GAIN.....	18
SUN OBSTRUCTION.....	19
PROTECTION AGAINST THE SUN.....	20
VENTILATION.....	21
MAKING THE RIGHT DECISION.....	22

INSULATION

WHY IS INSULATION NEEDED?.....	26
WHAT TO INSULATE FIRST.....	29
PARTIAL INSULATION.....	30
WALL INSULATION.....	32
CEILING INSULATION.....	40
FLOOR INSULATION.....	46
AIR INFILTRATIONS.....	52
INSULATION OF DOORS AND WINDOWS.....	53
INSULATION MATERIALS.....	55

MODELS AND OPTIONS

3-ROOM MODEL WITH INDIRECT GAIN.....	56
2-ROOM MODEL WITH INDIRECT GAIN.....	60
MODEL WITH DIRECT GAIN.....	64







This practical guide has been conceived in the frame of the « Pilot Initiatives for Green Homes in Tajikistan » implemented by GERES in partnership with the Scientific Research Institute of the Committee for Construction and Architecture of the Republic of Tajikistan.

Its purpose is to give generic guidelines to design and build energy-efficient individual houses in rural areas of Tajikistan (except high mountain areas). The solutions and models proposed in this manual are the results of the work of an international team composed of architects, civil engineers, energy specialists, local masters and craftsmen. They are mainly based on the collaboration with local communities of the districts of Rudaki and Hissar, in the Region of Republican Subordination of the Republic of Tajikistan.

The techniques and solutions proposed in this guide aim at improving the energy performance and the thermal comfort of the house in winter and summer, while ensuring the sustainability of the building and construction costs as low as possible.

Every house has specific needs which may require other techniques and solutions, therefore advice and supervision from an engineer, an architect or an experienced mason is highly recommended to ensure the building's performance and integrity.



Are you planning to build a house?

Call the Energy Information Centre | 98 700 52 52

Specialized experts can provide free consultancy to help you to design and build an Energy Efficient House:

- Advice for the selection of efficient materials
- Support to draw plans
- Estimation of the construction costs and bill of quantities
- Trainings on Energy Efficient Construction Techniques
- Information on Energy Efficient Solutions



The solutions and techniques introduced in this guide have been developed according to the following criteria:



Low Energy Consumption

(through passive solar techniques and insulation)



Thermal comfort

(through the selection of efficient insulation materials)



Fire Safety & Seismic resistance

(through the use of safe materials and solid structures)



Inside Luminosity & Practicality

(through efficient organization of the rooms)



Inside Air Quality

(through natural ventilation systems)



Cost Efficiency

(the best solutions according to budget availability)

All recommendations in this guide are based on current building regulations of the Republic of Tajikistan - МҚС ҚТ 23.02-2009 "Thermal protection of buildings" МҚС ҚТ 23-01-2007 "Building Climatology" МҚС ҚТ 22-07-2007 "Earthquake-proof construction. Design standards" МҚС ҚТ 50-01-2007 "Foundations of buildings and structures. Design Standards".

A good **South orientation**, with an angle of around 20° South-East or South-West offers natural sunlight and heat gains inside the house during winter.



Orientation

The roof shape is designed with an extension that aims to maximize the **heat gains in winter** and reduce the risk of **overheating in summer**.



Roof overhang

The living and bedrooms are surrounded if possible by **buffer zones** provided by the **bathroom** and the **kitchen** on the northern side and by the veranda on the southern side. This increases the compactness of the building and its capacity to keep heat.



Buffer zones and compacity

A minimum of 4cm of **external insulation** on the walls, the ceilings and double-glazed windows is essential to limit heat losses and provide **thermal comfort** inside the house during winter.



Insulation

Airtight double-glazed windows and **efficient doors** limit cold air infiltrations in winter and **keep the house warm**.



Doors and windows

The windows are positioned in a way that permits **cross ventilation**. The objective is to **increase thermal comfort** in the summer and limit the risk of moistures.



Cross ventilation

Reinforcement of strategic junctions for the house: foundations, walls/ceilings, ceilings, windows, increases **the seism resistance of the building**.



Anti-seismic measures



Solar radiations can be converted into useful energy and used to heat the house.

Passive solar heating methods can be easily applied to new buildings by using windows, verandas, walls and floors

to collect, accumulate and distribute thermal energy.

The first part of the guide will provide basic methods to optimize the collection of passive solar energy.

Elements to be considered include: placement and size of the windows, glazing type, thermal insulation, thermal mass and shading

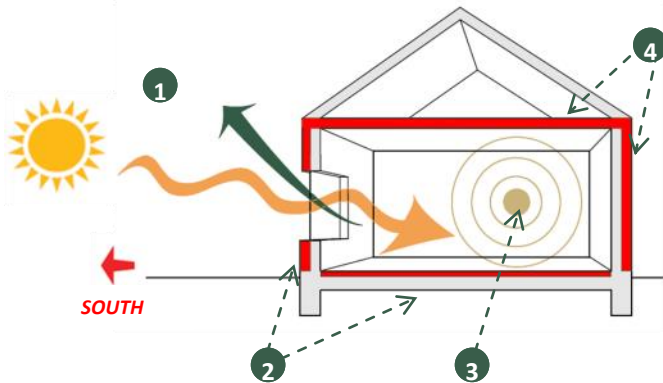

1. Collection of a maximum amount of solar radiations during the day
2. Storage of the heat in the walls and the floor
3. The heat is released inside the rooms during the evening and at night
4. Insulation of walls, ceiling and windows to reduce heat losses

Depending on the season and orientation of the house, the amount of solar radiations received by each surface of the house varies.

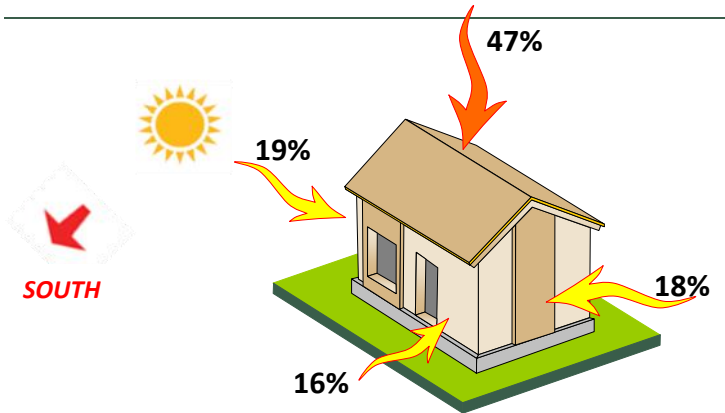

During the summer, the sun is higher in the sky...

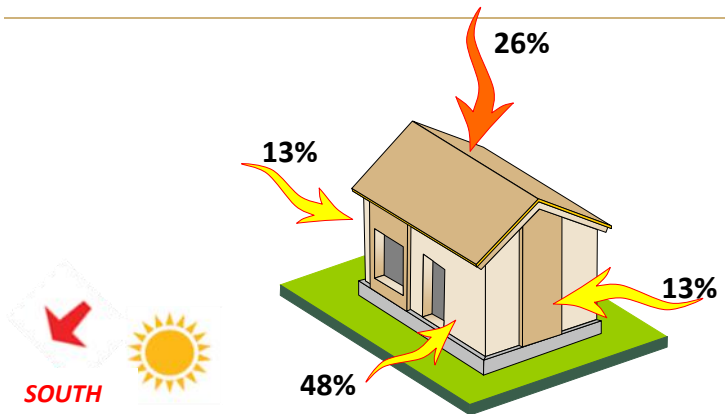

... and in winter it is lower

Therefore, the orientation of the building is very important to optimize the collection of solar energy



South orientation can be determined with a compass or in relation to the sun.

To maximize the use of solar energy for space heating, large windows must face the south. If the windows are installed on the north, the house does not reap the benefits from the sun. Windows installed on the eastern or western side result in limited benefits from the sun and overheating in the summer.



Facade with main windows to the south



Back facade facing the north

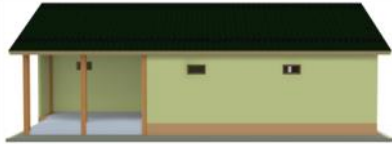

Facade with main windows to the north



Facade with windows to the west



Facade with windows to the east

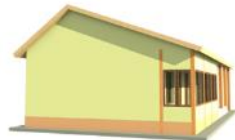

Sometimes the building plot does not allow to build with an exact southern orientation. In such cases, it is possible to deviate the orientation of the house south-west or south-east.

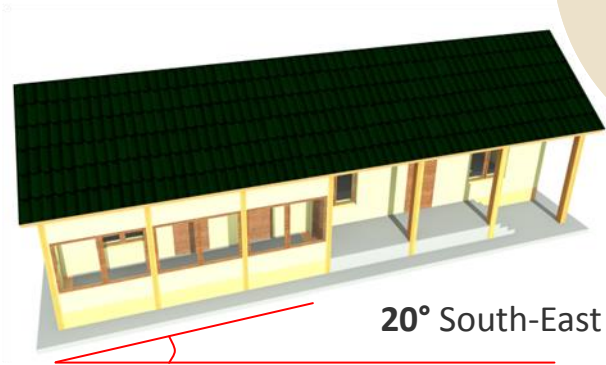
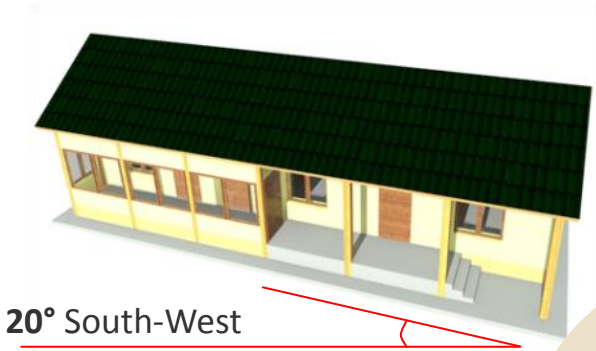

The maximum angle of deviation from the south to south-west or south-east must be 20°.



1st method—by using a compass



1. Ring;
2. Baseplate
3. Needle
4. Orienting lines,
5. Red arrow;

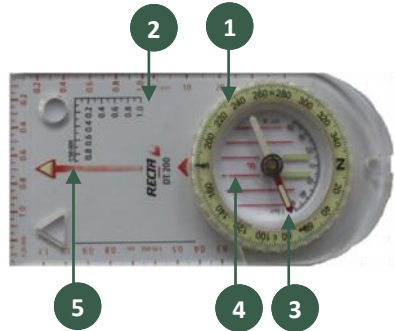

1

Align the "South" of the ring with the red arrow



2

Place the compass on a flat surface, wait until the needle stops ;



3

Rotate the baseplate of the compass to align the "North" of the ring with the of the red arrow. The red arrow will then indicate the southern direction.



During its utilization the compass should be as far as possible from magnets and metal objects

2nd Method— with the help of the sun

At Dushanbe time, the sun is at its highest during the following hours:

- In February at 12:40
- In October at 12:10
- For other months it is between the two times

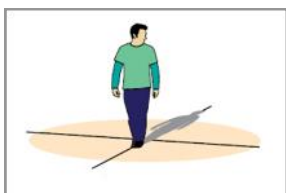
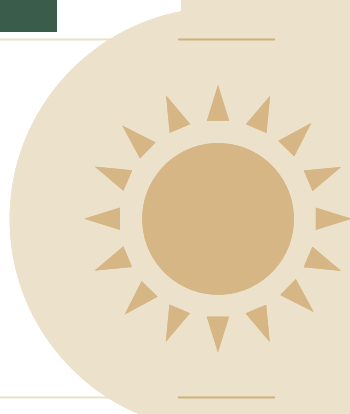

At its highest, the sun indicates south, during which the shadows of objects are the shortest.

1



As illustrated, the tip of the shadow will point north, signifying that the south is on the opposite side.

2



When compared, the shadow of the stick and the red arrow on the compass align.

3



When designing a house, one should consider the option of positioning the rooms adjacent to each other.



Separate location of individual buildings on a plot

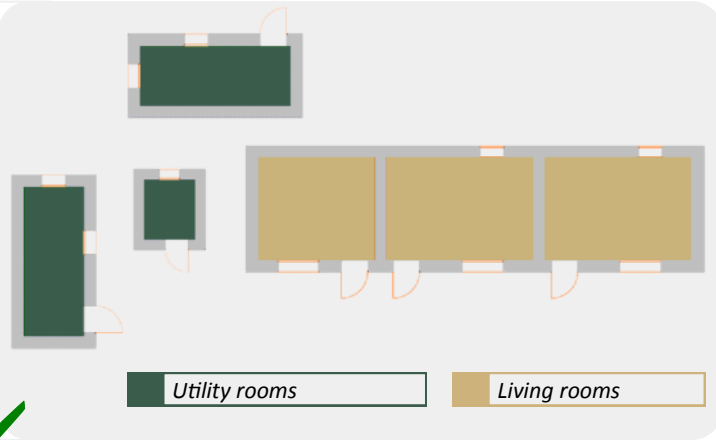

Compact arrangement of residential and ancillary facilities

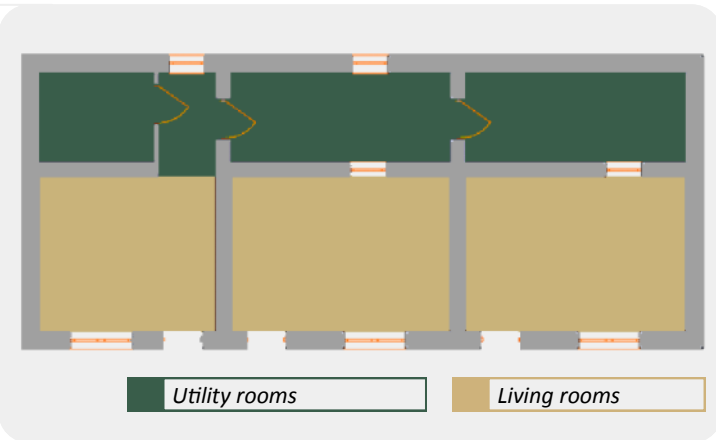

Combining spaces which generate heat will reduce fuel consumption; for example, the bathroom and the kitchen can be attached to the living spaces.

ROOM LAYOUT

A proper arrangement of rooms ensures the supply of solar heat in the winter to areas where it is most needed. The vestibule in turn prevents the inflow of cold air when the door is open.

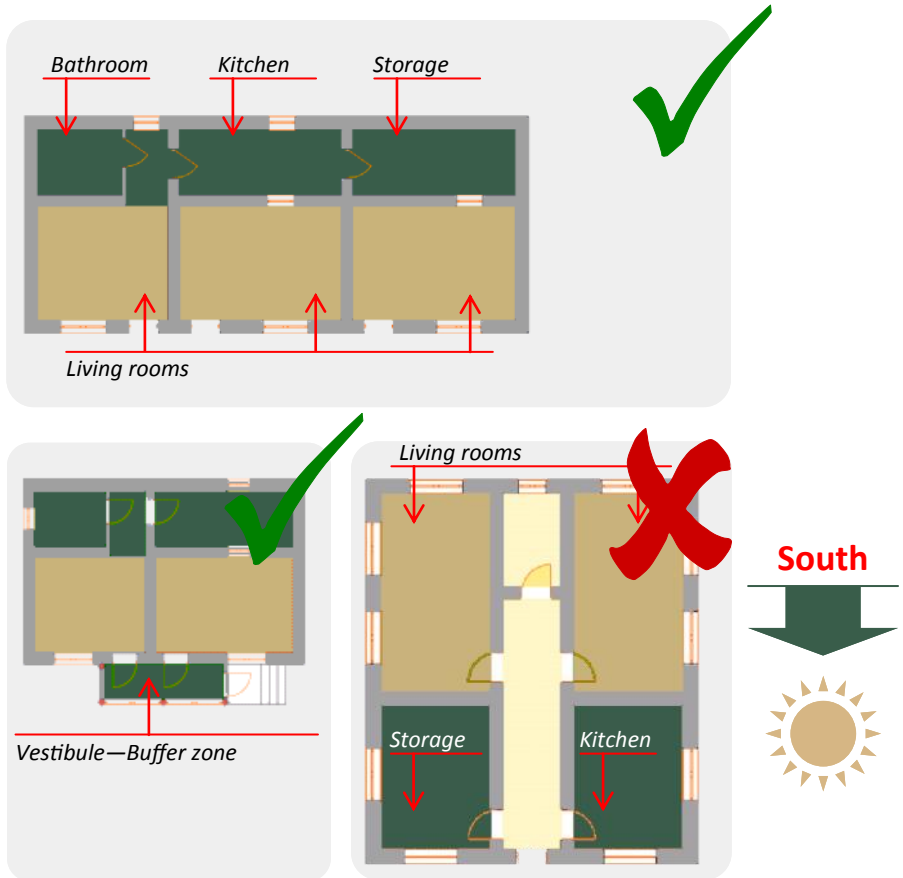

The living rooms are positioned on the south and the utility rooms (kitchen, bathroom and others) on the north.



There are two principal ways of acquiring solar energy: through direct and indirect gain.

In the case of the direct gain, the room is heated by the sunrays radiating directly inside through the south-facing windows. A portion of the heat is used immediately, while the other is accumulated inside the walls, floor, ceiling, furniture and is released at night.

The floor plays the role of an accumulator, as the solar radiations directly falls on it.

However the rug that is traditionally used in houses reduces its capacity of storage.

Additionally, to limit the heat from escaping through the windows, it is recommended to use curtains.

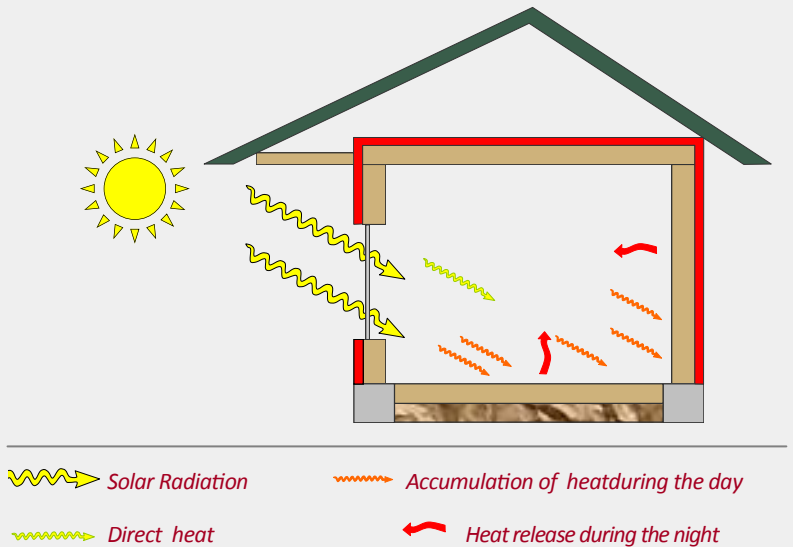

In order to accumulate more heat, the walls and floor should be massive

Advantages and drawbacks of the direct gain

Advantages

Affordable

Aesthetic

Rapid heating if SE oriented

Applies to houses oriented SE - 20° to SW - 20°

drawbacks

Delayed heating if oriented SW

In the absence of thermal mass, it is cold at night

It is cold on cloudy days

The area of the window plays a major role in direct heating. To optimise direct solar heat, the south-oriented window glass must be of a certain area in relation to the floor area. For living areas, this ratio ranges from 0.12 to 0.17* (optimum 0.15). The glass area, on average, should make up 60% of the total area of the window.

For rooms that are used only during the day (such as classrooms), this ratio ranges from 0.17 to 0.22 (optimum 0.19)

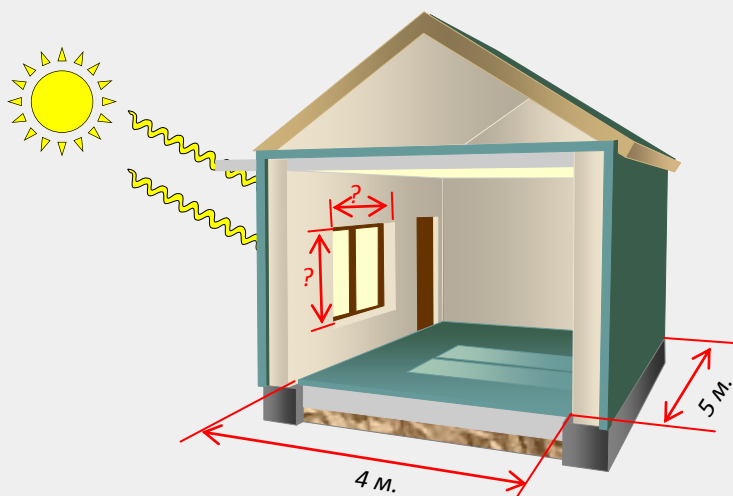

Example:

Let us calculate the required window area S_{OK} for the solar heating of the room with dimensions of 4m x 5m.

$$S_{OK} = 0,15 * 4 * 5 / 60\% = 5m^2$$

we can thus install two windows, each with the size of 1,5x1,67m

Table 1. Area and window sizes for different rooms

Dimensions of the room	Dimensions of the window	Number of windows	Dimensions of the room	Dimensions of the window	Number of windows
(3x3,5) 10,5m ²	2,62m ²	1,5x1,7 (1pcs) или 1,5x 0,9 (2pcs)	(3,5x4) 14m ²	3,5m ²	1,5x1,15 (2pcs)
(3x4) 12m ²	3m ²	1,5x2 (1pcs) или 1,5x1 (2pcs)	(3,5x5) 17,5 m ²	4,37m ²	1,5x1,5 (2pcs)
(3x5) 15m ²	3,75m ²	1,5x1,25 (2pcs)	(4x5) 20m ²	5m ²	1,5x1,7 (2 pcs)
(3x6) 18m ²	4,5m ²	1,5x1,5 (2pcs)	(4x6) 24m ²	6m ²	1,5x2 (2pcs)



Indirect gain occurs when there is a veranda on the southern side of the house. The sunrays heat the veranda as they enter it. When the temperature of the air in the veranda is warm enough, opening the windows allows for the warm air to circulate into the adjacent rooms. If the veranda is made of polyethylene film, a part of the solar energy enters directly into the room and heats it. If the veranda has a roof, then rooms gain only from indirect heat.

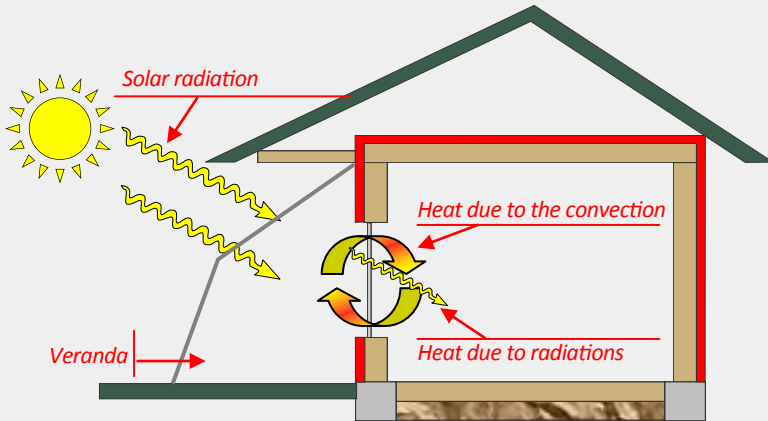

Example of a solar veranda

The cost of solar veranda buildings range from 100 to 150 somoni per 1m².



The solar veranda requires ventilation to avoid moisture.



SUN OBSTRUCTION

In winter, the sunrays should reach the rooms. However, the neighbouring houses, large trees, fences and other barriers may obstruct the sunlight. This can be avoided through the evaluation of potential shadows created by nearby objects. The results from calculations are shown in the table below.

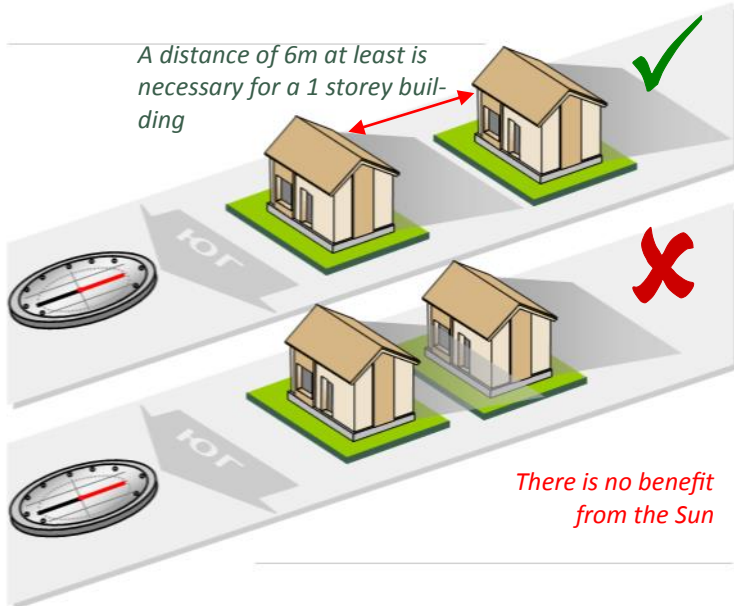

Table 2: Required distance between the house and bar-

Height of the obstacle (m)	2	3	4	5	6	7	8	9
Minimum distance from the obstacle	2,2	4	6	8	10	12	14	16

The calculations above are for the month of December, when the sun is low in the sky (at 28°) and the shadow of the objects are the longest.

PROTECTION AGAINST THE SUN

PROTECTION AGAINST



To prevent the sun from overheating the premises, horizontal protections or overhangs must be installed. The length of the overhang depends on the angle of the sunrays, which in turn, varies according to the time of the year.

63° — Angle of the rays falling on a horizontal surface in April.
H — Height from the bottom of the window to the bottom of the cornice
L — Length of the overhang

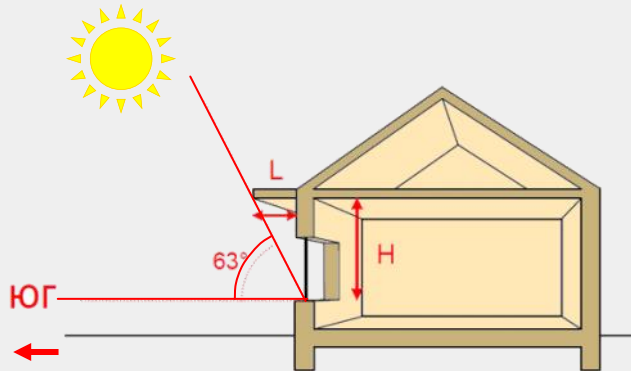

The table shows the calculations of length **L** of the roof overhang at different heights **H**:

H, м	1,7	1,8	1,9	2,0	2,1	2,2	2,3
L, м	0,8	0,85	0,89	0,94	0,99	1,04	1,08

Sunray angles are the same between April and August. Therefore, the rays begin entering the room towards the end of August.

If there is a grape trellis near the facade of the building, the roof overhang is not necessary, because in summer the leaves will prevent the sun rays from entering the rooms.

VENTILATION

Inhabitants of the house produce heat, humidity and carbon dioxide. Humidity can also come from the kettle on the stove. It is therefore necessary to remove these excesses and ventilation is the best way to do it.

Supply air flow through the main doors and windows

Upward flow of air through the northern small windows

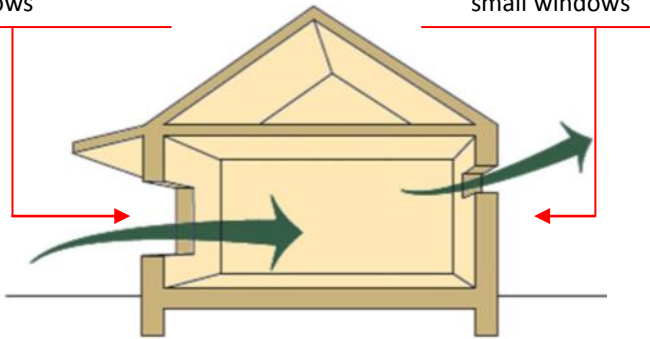

To create cross-ventilation, southern and northern windows must be open at the same time.



WINTER:

Open the windows on the southern side AND on the northern side for at least 5 minutes every morning.

SUMMER:



Opening the doors and windows on both sides of the house will enhance a natural cross-ventilation and prevent overheating. If you let them open during the whole night it will cool down the rooms.



If you prefer having a veranda you have two options

Indirect gain:

- ⇒ The veranda is oriented towards the south
- ⇒ The windows of the living rooms are also oriented south for natural lighting and for the acquisition of heat from the veranda during the day.
- ⇒ Small windows on the north side for cross ventilation.

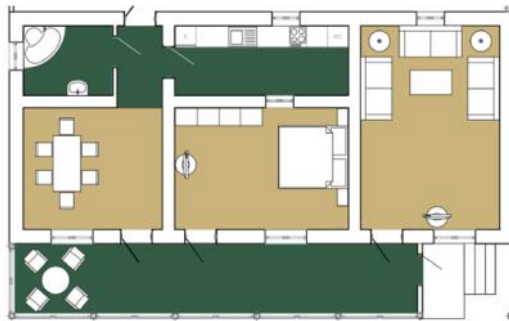

South



Direct Gain

- ⇒ The veranda is oriented towards the north
- ⇒ The windows are positioned on the southern side for the acquisition of natural light and direct heat from the sunlight. The sizes of the windows should correspond to calculations provided on P. 17.
- ⇒ In this case, opening the doors for cross ventilation is sufficient. It is unnecessary to have windows on the northern side.

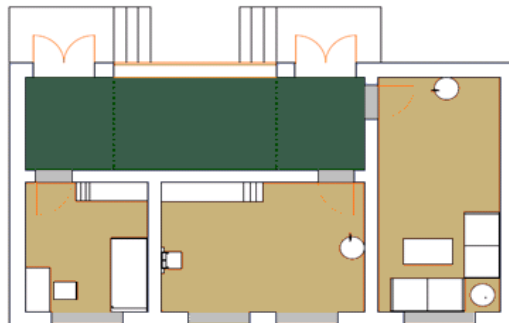



Combination of direct and indirect gain

- ⇒ The vestibule is oriented towards the south
- ⇒ The corridor is near the vestibule to acquire heat in the day
- ⇒ The windows are positioned on the southern side to get the natural light and direct heat from the sun. The window size must correspond to calculations provided P. 17.
- ⇒ Small windows on the north side for cross ventilation.

If you prefer not having a veranda, you have 2 options.



Direct gain:

- ⇒ The windows are positioned on the southern side for natural light and direct heat from the sun. The size of the windows must correspond to calculations provided on P. 17.

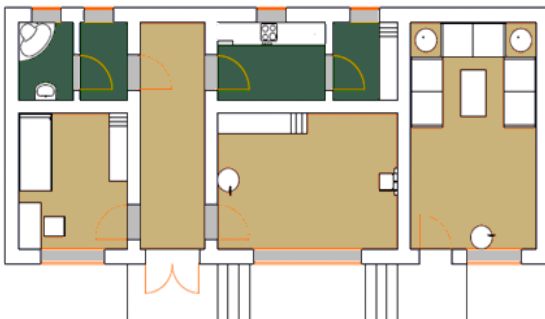
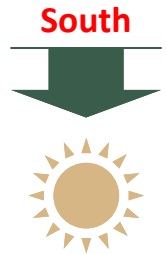



The size and position of windows:

Windows play the following essential roles in your home:









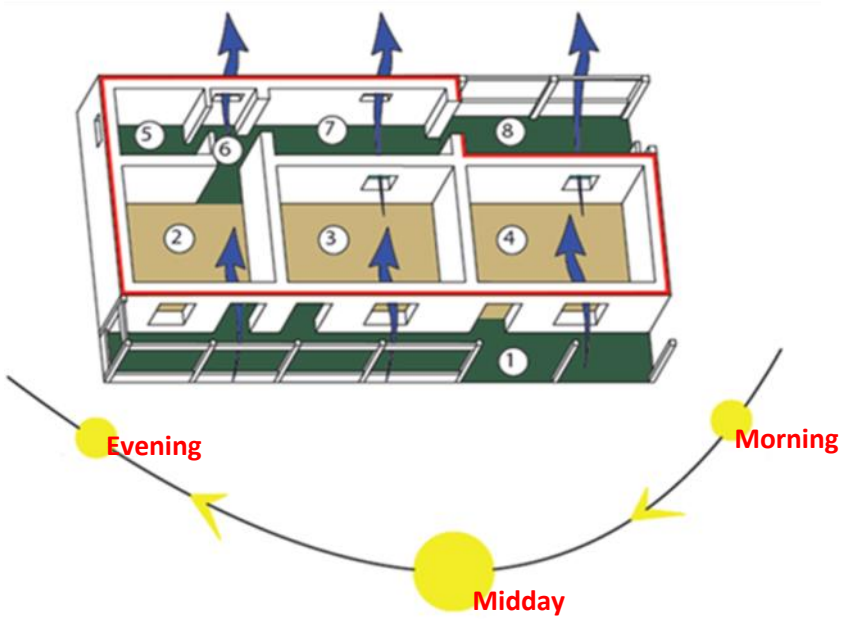



- ⇒ They ensure solar radiation for heating
- ⇒ They bring natural light into the rooms
- ⇒ They allow a good air ventilation
- ⇒ They can increase the heat losses in the building (as needed for the summer)

It is recommended that you follow these rules:

- ⇒ Never place the large windows on the northern facade
- ⇒ Try to put medium-sized (for indirect heating) or large windows (direct heating) on the southern facade
- ⇒ Always place windows or at least openings (such as doors) on opposite sides of the house (north and south)
- ⇒ The living room should be aligned along the east-west axis with medium / large windows on the southern side.

An example of efficient design



-  Buffer Zone
-  Living rooms oriented towards the south
-  External Insulation
-  South orientation
-  Cross-ventilation
-  1 Veranda and shed
-  2 Winter room
-  3 Bedroom
-  4 Guest room
-  5 Bathroom
-  6 Corridor
-  7 Kitchen
-  8 Storage



In theory, an average of 3240 kg of coal are needed to heat fully a non-insulated 3-bedroom house for one winter. For an insulated house it is only 1160 kg. Consequently, 2080 kg of coal can be saved per season. The repartition of heat losses through the envelope of a non-insulated house are illustrated below.

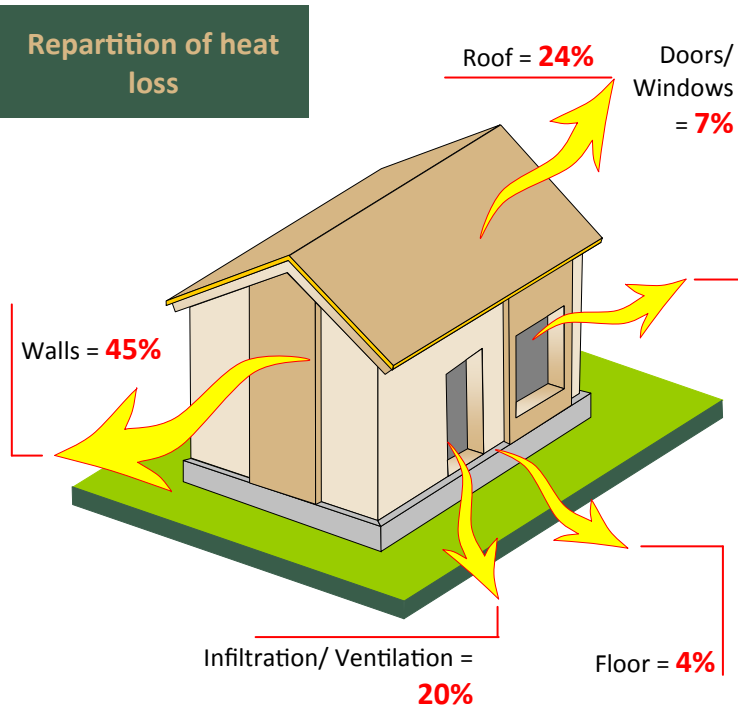

Although the majority of the heat escapes through the roof and walls, in order to achieve thermal comfort, it is necessary to also insulate windows and doors.



In a non-insulated house, the temperature of the inner surface of the outer layers is lower. In this case, even if the inside temperature of the air may equal 18 °C, the state of comfort of a human is lower than at the same temperature in an insulated house.

Temperature of the inner surface of the outer wall:

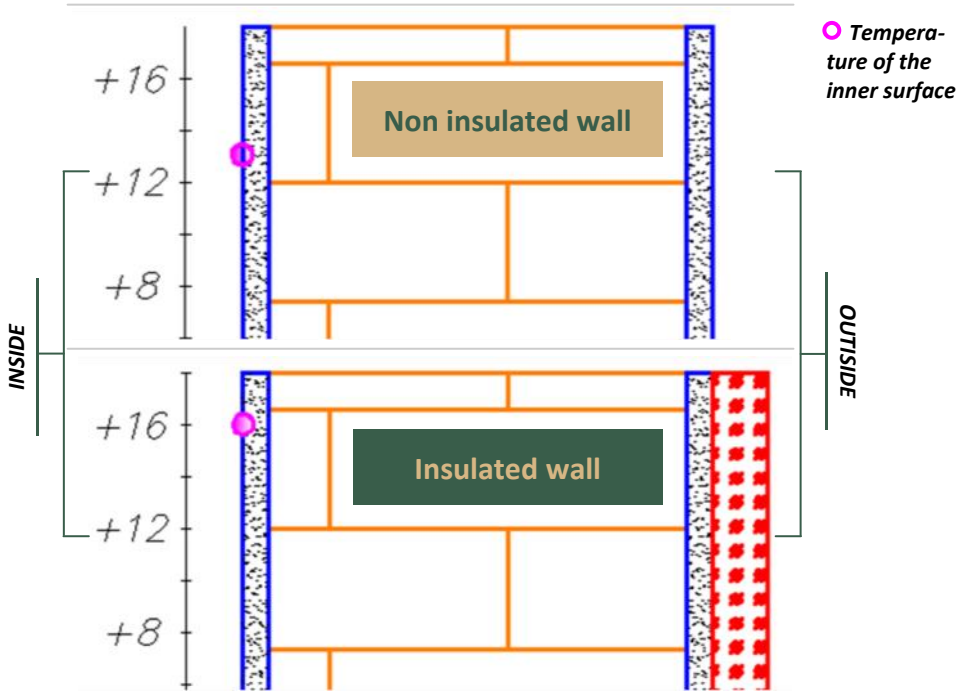

In an insulated house, the temperature of the surface of the wall rises by 4 °C, thus increasing the personal comfort.



Double-glazed windows are more costly than single-glazed windows, however the thermal resistance of double-glazed windows is significantly higher and they overall provide much better comfort.

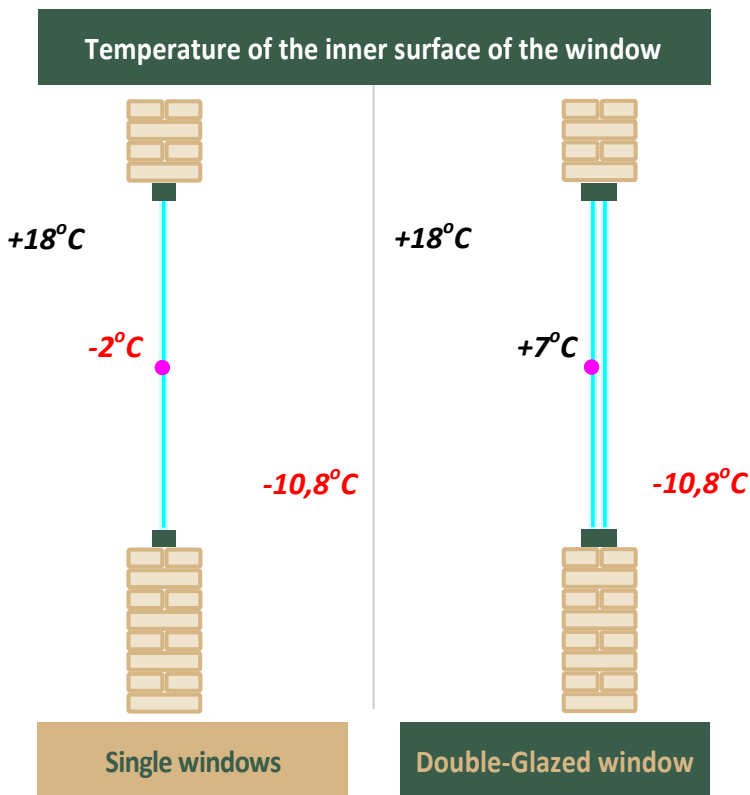

When using double-glazed windows, the temperature of the surface of the inner glass rises by 9°C



WHICH PART TO INSULATE FIRST?

Insulating the entire house is not always easy. In such cases, it is important to select a part of the house which needs to be insulated first. According to the diagram on P. 26, almost half of the heat escapes through the walls. Therefore, **by insulating the outside walls, you can conserve the majority of the heat.** However, the cost for insulating walls is very high and takes much longer to pay off.

Table 3: Payback period for insulation measures (when one corner room with kitchen and bathroom are heated)

Part of the building to be insulated	Material used for insulation	Area, m ²	Cost of insulation, TJS	Coal Saving, kg	Payback period (years)
Outer Walls	Mineral Wool	50.1	4208.4	380	24.6
Ceiling	Reeds	32.1	385.2	305	2.8
Doors and windows	Double glazed & rubber	5.4	720	155	10.3
Outer Wall + Doors and Windows		55.5	4928.4	535	20.5
Ceiling + Doors and Windows		37.5	1105.2	501	4.9

As seen above, **insulating the ceiling, requires minimal expenses and conserves a high amount of heat.** You can achieve particularly good results if you combine this with insulated double-glazed windows.

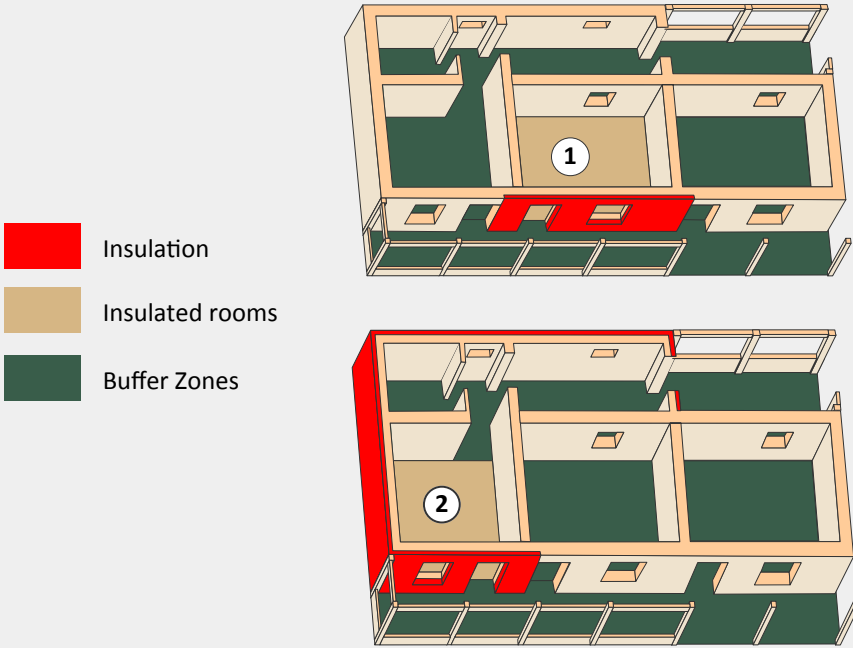

**The cost of insulation includes insulation of the walls, of the roof, doors and double-glazed windows.*

Options for insulation	Insulation			
	Total Cost (TJS)	Cost for 1M ² of floor (TJS)	Coal Saving per season (kg)	Payback period (years)
1. Middle Room, 17.5 m ²	1839.6	105	344	8
2. One corner room with buffer zones, 32,1 m ²	5640	176	836	11

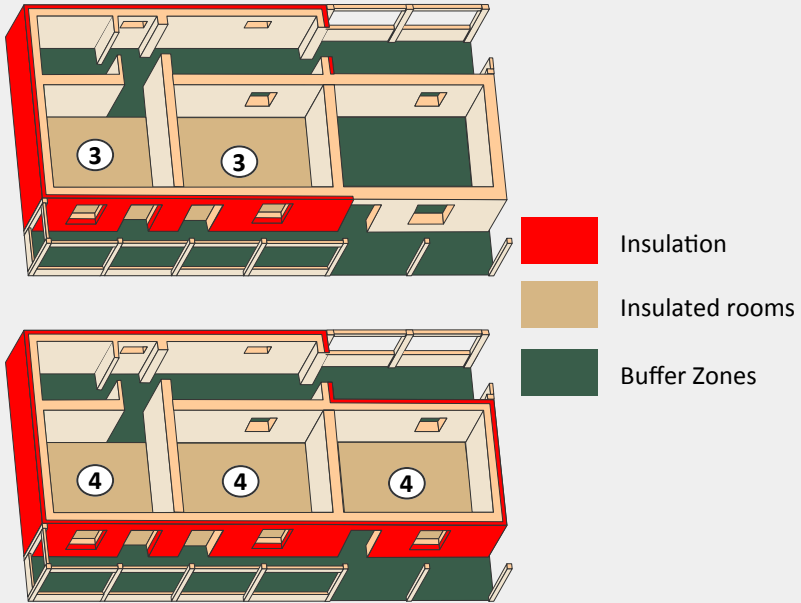

Options for insulation	Insulation			
	Total Cost (TJS)	Cost for 1m ² of floor (TJS)	Coal Saving per season (kg)	Payback period (years)
3. Two rooms with buffer zones, 49,6 m ²	7320	148	1023	10
4. Full House, 67,1m ²	14149	211	2137	13

**The cost of insulation includes insulation of the walls, of the roof, doors and double-glazed windows.*



Required thickness of the insulation, if the brick wall is 38cm thick:



Polystyrene – 3cm



Mineral wool—4 cm



Reeds – 8cm

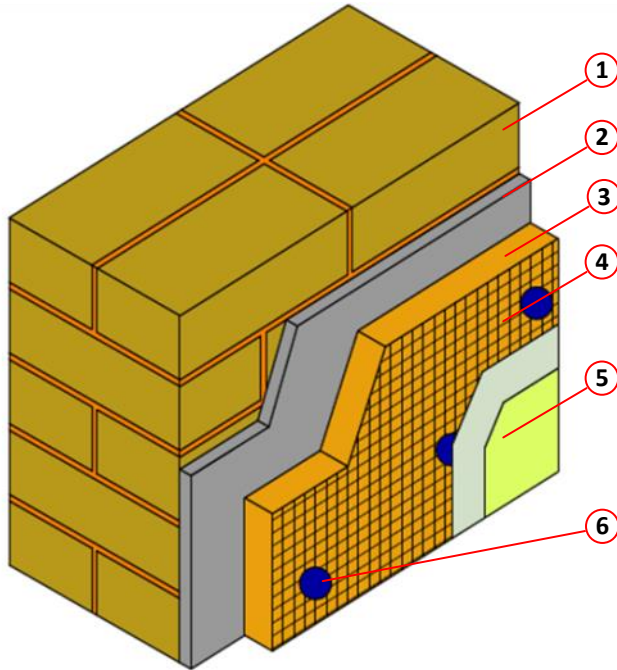

1. Brick outer wall
2. Cement-sand plaster
3. Insulation blocks made of mineral wool
4. Fiberglass net on glue
5. Outer decoration layer
6. Plastic dowels

The proposed insulation materials for outer walls have been selected for their affordability and according to various market prices.



Step 1.
Flatten the surface of the wall by applying a plaster on it



Step 2.
Prepare the adhesive solution. (Ceresit CT 180" or CTC -190)



Step 3.
Cut the mineral wool plate in accordance with the preliminary measures of the wall

Be careful! The installation of mineral wool plates must be executed in accordance with specific installation techniques.



Step 4.

Apply the adhesive solution with a notched spatula on the mineral wool



Step 5.

Install the mineral wool on the wall



Step 6.

Install the plastic dowels on the mineral wool to fix the plates to the wall



Mineral wool is heavy: the adhesive solutions must be applied entirely. Five to seven plastic dowels per square meter of mineral wool must be used.



Step 7.
Glue a 20cm wide net on the corners



Step 8.
Apply the glue on the plastic angles



Step 9.
Glue a 20 cm wide net on the plastic angles

To glue the net to the plastic angles you can use the glues "Master" or "Moment".



Step 10.
Apply the adhesive solution on the windows and doors slopes.



Step 11.
Glue the plastic angle with the net on the corners between the frame and the wall;



Step 12.
Reinforce the upper corners with a piece of net.



**One package of net is enough for 70 m² of wall surface.
For 1 m², 3kg of adhesive solution is needed.**



Step 13.
Cut the net according to the dimensions of the wall



Step 14.
Apply the glue on the mineral wool and put the net on the glue. When putting the nets, two nets must overlap by 10 cm.



Step 15.
Apply the last decorative layer.

When you glue the net the joint between two nets must overlap by 10cm.



Before gluing the mineral wool, the surface of the wall must be free of any dust or other dirts



Insulation on windows and doors slopes must be twice thinner.



To prevent any problem in the finishing, plastic dowels must be well pushed inside the insulation material.



When installing the insulation plates, pay attention to their verticality and horizontality using a water level.



If necessary the gaps between the plates must be filled with leftover mineral wool.



If there is no plinth at the base of the wall, a guiding profile must be installed under the mineral wool.



To avoid thermal bridges, insulation of the wall must exceed insulation of the ceiling.

There must be no gap at the junctions between the mineral wool plates.



Required thickness of the local thermal insulating materials:

Ceilings of houses can be insulated in two ways:

- ⇒ Above the ceiling, in the attic
- ⇒ Under the ceiling, between the beams



Straw -12cm



Reeds -15cm



Sawdust -12cm

Insulation of the ceiling from the top using local materials

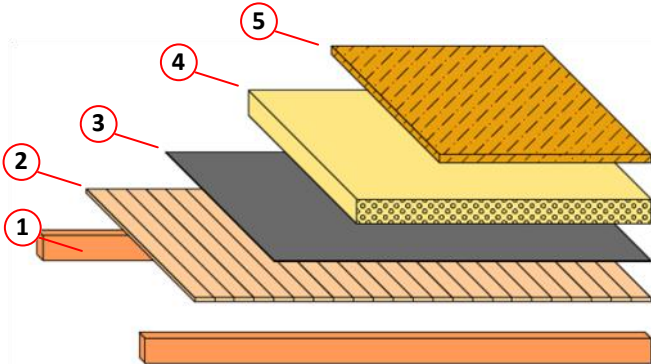

1 – Wooden beams; 2 – Ceiling board; 3 – Vapor barrier; 4 – Reeds for insulation 5 – Straw and clay layer

- Clay plaster
- Waterproofing
- Insulation
- Vapor barrier



Local materials must be treated with a fire retardant and anti-septic. Lime powder can be used as an antiseptic.



Step 1.
Dry and clean the reeds and tie them into bundles



Step 2.
Mix the fire retardant powder with water within the right proportion and fill a sprayer with it.



Step 3.
Spray the solution on the reeds.

**The proportions for the flame retardant must be the following:
2 tablespoons for 1 liter of water**



Step 4.

Install the vapor barrier on the ceiling boards. Layer the reeds and apply the antiseptic (lime powder) ;



Step 5.

Layer the 5cm thick clay plaster on the reeds



For 1m² of surface, 500g of lime powder must be used.

Insulation of the ceiling from the bottom between the beams

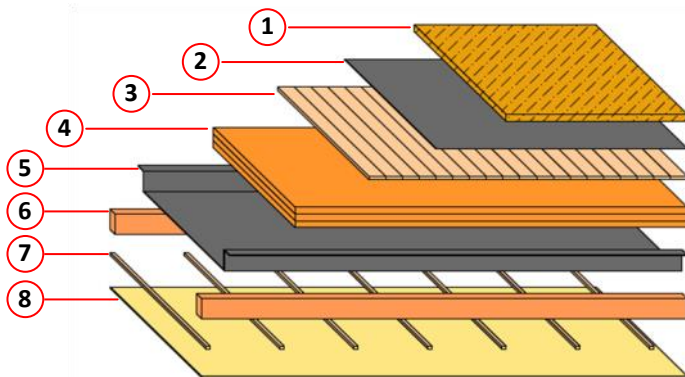

1. Clay and straw layer;
2. Waterproofing layer;
3. Ceiling board;
4. 3-layer insulation;
5. Vapor barrier;
6. Wooden beams;
7. Profiles
8. Ceiling cover

Insulation options and required thickness



When using polyurethane foam or straw as insulation, vapor barrier and waterproofing layers are not necessary.



Step 1.

Measure the distance between the beams;



Step 2.

Install the vapor barrier;



Step 3.

Cut the required size of mineral wool;



There must be no gap between the elements of construction and insulation.



Step 4.
Install the insulation between the beams and fix it temporarily;



Step 5.
Install the vapor barrier



Шаг 6.
Assemble the ceiling along the guiding profile to fix all the layers

When selecting insulation materials, attention should be paid to the density, fire resistance and environmental characteristics.



Two types of floor can be used for the construction of an energy efficient house:

- ⇒ Floors directly on the ground
- ⇒ Floors on beams

1. Laminate or linoleum
2. Insulation layer made of clay
3. Waterproofing layer
4. Levelling layer of sand
5. Filling made of sand and clay
6. Compacted soil base

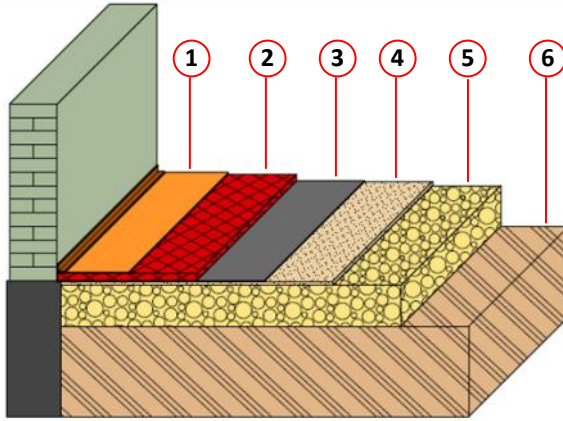

Floor directly on the ground

Options for insulation



Polystyrene



Clay with straw



Expanded clay

Floors that are directly on the ground do not require massive insulation but need a good waterproofing.



Step 1.
Tamp the foundation soil under the floor



Step 2.
Fill the trench with a mixture of gravel and clay



Step 3.
Add a leveling layer of fine sand

The fine sand must be dry before being laid



Step 4.

Install the waterproofing layer of polyethylene film;



Step 5.

Layer the 5 cm thick straw and clay plaster;



Step 6.

Install the flooring laminate or the linoleum



It is recommended to apply a layer of gauze when layering the clay to prevent the appearance of cracks once it dries out.



Floor on beams

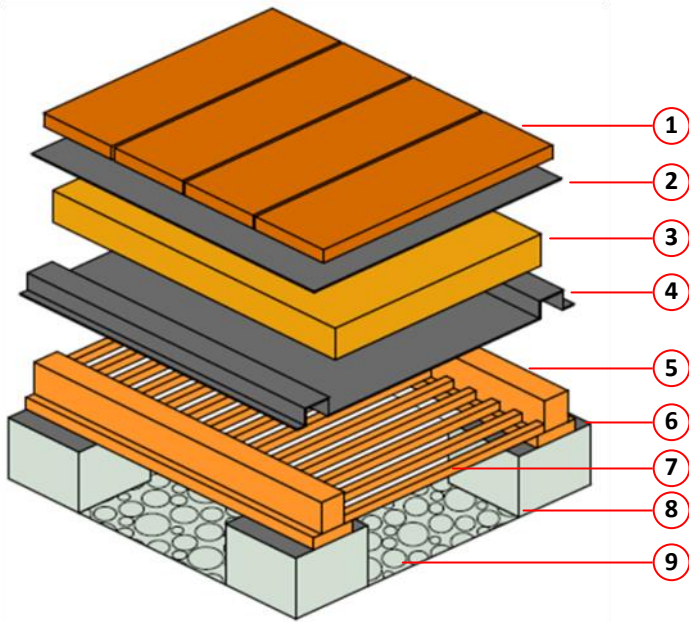

1. Floor; 2. Vapor barrier; 3. Insulation block; 4. Waterproofing layer; 5. Wooden beams; 6. Rough floor; 7. Wooden floor racks; 8. Concrete or bricks; 9. Compacted soil ground



Insulation with straw



Insulation with mineral wool

Insulation options

Insulation between beams is done when there is a raised floor and when there is a ground floor



Step 1.

Tamp the foundation soil under the floor



Step 2.

Build concrete or brick columns;



Step 3.

Place a waterproofing layer over the columns and install the wooden beams;



When applying hydrophobic materials, waterproofing and vapor barrier layers are required.



Step 4.
Arrange the wooden floor racks between the beams



Step 5.
Install the waterproofing layer and then the insulation boards



Step 6.
Lay out the vapor barrier and apply floor boarding.

Insulation between the beams should be stacked without gaps and crevices.



Air infiltrations occur because of the difference of pressure between inside and outside that makes the cold air come inside. The intensity of air infiltrations is greatly increased when there are gaps on the windows and doors.



Windows with gaps

Non air-tight doors



Gaps in windows and doors are usually a main source of thermal discomfort in a house.



With self-adhesive rubber



Sealing of window frames



Sealing of doors



Different types of self-adhesive rubber

Step-by-step instructions:

1. Gradually remove the protective film (so that the glue does not have time to dry out)
2. Glue the adhesive side along the perimeter of the window or the door
3. Cut the leftover section

Avoid sealing windows and doors when the outside temperature is low. The tape does not adhere, or adheres poorly and is not reliable.



Insulation of doors and windows:

Outside doors can be insulated with an extra 3cm thick foam

Step-by-step Instructions:

1. Cut the foam with a gap of 1cm between the perimeter of the perimeter and the edge of the door;
2. Cut the leather with a margin of 5 extra cm with the perimeter of the door .
3. Wrap the foam in the leather and let 1 cm exceeding the size of the door.
4. Prepare leather straps and nail them to the door.



Insulated door

Double-glazed windows store twice as much heat as single-glazed windows.



Double-glazed window

Remember: the durability of cheap plastic windows is limited. We recommend to use wooden windows with double glazing, particularly those with a leaf.



INSULATION MATERIALS

Materials	Thermal Conductivity	Cost	Fire Safety	Humidity resistance	Durability	Compression	Environmental Impact
Mineral Wool	Good	Bad	Good	Average	Good	Average	Average
Glass Wool	Good	Average	Good	Bad	Good	Bad	Average
Expanded polystyrene (EPS)	Good	Average	Bad	Good	Good	Average	Average
Extruded Polystyrene (XPS)	Good	Bad	Average	Good	Good	Good	Average
Straw	Average	Good	Average	Average	Average	Average	Good
Reeds	Average	Good	Average	Average	Average	Good	Good
Wool	Average	Good	Average	Bad	Average	Average	Good



Good



Average



Bad

Before buying any insulation material, it is necessary to pay attention to the quality certificate or technical certificate, which shows **the thermal conductivity of the material**. The lower this ratio, the better the insulation material.

You must also pay attention to **the density of the material**, for example, if the walls are warm mineral wool, minimum density of insulation must be 130 kg / m³.



South facade



North facade



Front view

Total estimated cost of the house | 86 000 TJS

Total area | 96m² - Heated area | 68 m²

Cost for 1 m² - 900 TJS

Energy consumption | 57,5 kWh/m² *year (Class C)

1 160 kg of coal / winter (fully heated house)

Total saved compared to a non-insulated house - 935 TJS/year

57.8 kWh/m²*year is the energy consumption targeted by the Tajik Norm, with a tolerance margin of 9%.

The energy-efficient house will consume 1.16 T of coal per year (full heated house), while the traditional one would consume almost three times as much: 3240 kg of coal per season. If the house is north oriented rather than south, the consumption will increase by 16% (around 200 kg of coal per season).

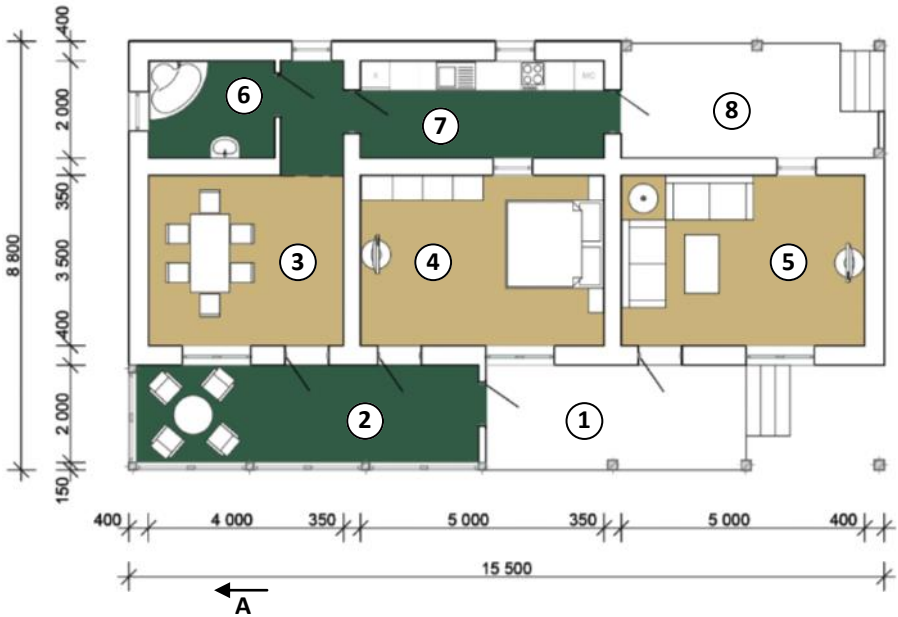
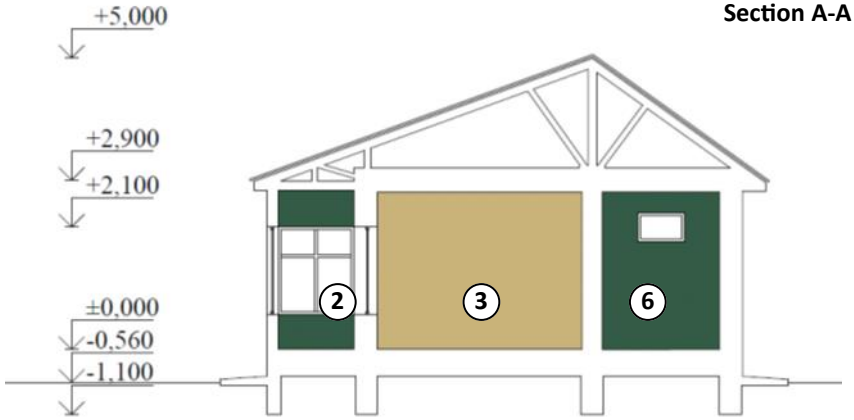

① Open veranda
8,1 M²

③ First room
17 M²

⑤ Guest room
17,5 M²

⑦ Kitchen
10 M²

② Closed veranda
9,5 M²

④ Second room
17,5 M²

⑥ Bathroom
5,1 M²

⑧ Storage
10,5 M²



The proposed materials have been selected according to local availability, prices and technical efficiency. However, other decisions can be made according to budget availability and specificity of the house.

Part of the construction	Total Volume	Estimated cost of materials	Cost for 1m ² of construction
Rubble-concrete foundation	29 m ³	5 410	74,6
Walls (mudbricks)	53,5m ³	5 710	25
Wooden ceiling	4,6 m ³	7 485	70
Wall insulation with mineral wool	130 m ²	9 045	68
Ceiling insulation with reeds	126 m ²	1 854	15
Reeds	130 m ²	7 045	54
Mud floor	52 m ²	3 634	70
Windows	7,1 m ²	2 892	420
Doors	13,6 m ²	3 400	250
Antiseismic measures	-	4 097	90
Other	-	7 176	107
Total		57 748*	
Transportation and labour		28 252	
TOTAL COST OF THE HOUSE		86 000 TJS	

**Prices of construction materials may vary depending on the market price*



Variant A-2

A vestibule replaces the closed veranda. An inconvenience is that it does not accommodate space for a tapchan or other commodities. The advantage is that the solar gain through the windows on the south will increase.



Variant A-3

This variant proposes a store-room (saray) at the northern side, directly accessed through the corridor. The veranda can also be extended along the whole southern side and/or be completely open.

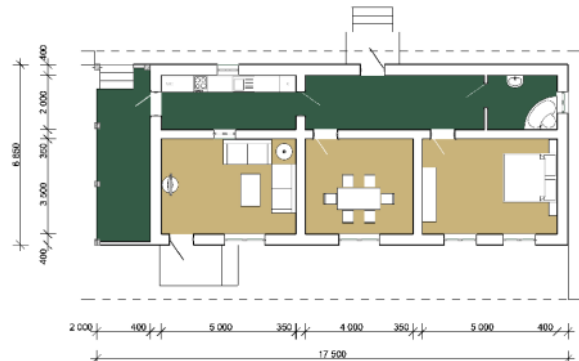

Variant A-4

The rooms are accessed through the northern corridor. The size of windows on the south facade of rooms can be increased. This increases the solar heat gain to the rooms but limits direct access from the south.



South facade



North facade



Front view

Total estimated cost of the house | 75 000 TJS

Total area | 58 m² - Heated spaces | 33 m²

Cost for 1 m² - 1300 TJS

Energy consumption | 61,3 kWh /m²*year (classe C)

913 kg of coal/winter (fully heated house)

Total saved compared to a non-insulated house - 674 TJS/year

The proposed design of the house will consume 913 kg of coal per year (with a full heated house), while the traditional house would consume almost three times as much: 2 411 kg of coal per season. With an improved stove, the fuel consumption of the green home can be decreased by up to 640 kg per heating season.

The total cost of the green house with two rooms is around 75 000 somoni, which is 20% higher than a traditional house.

Section A—A

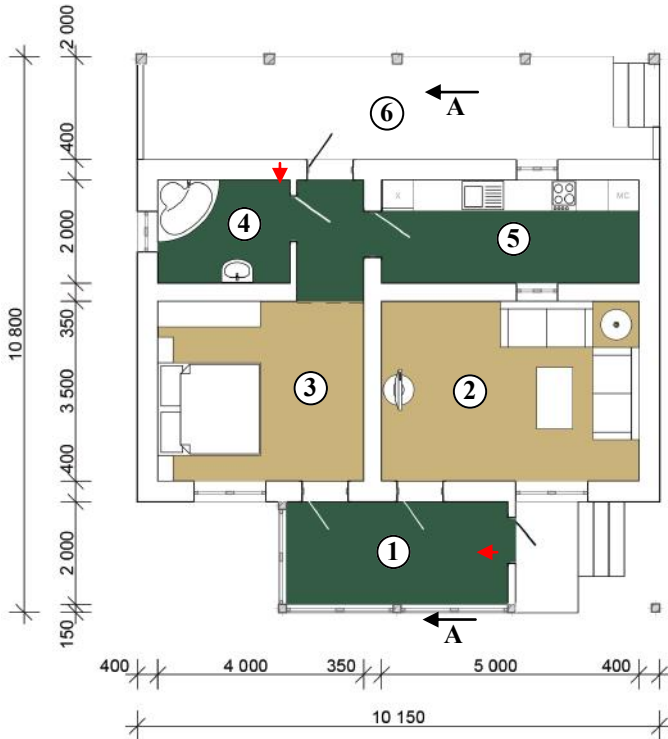
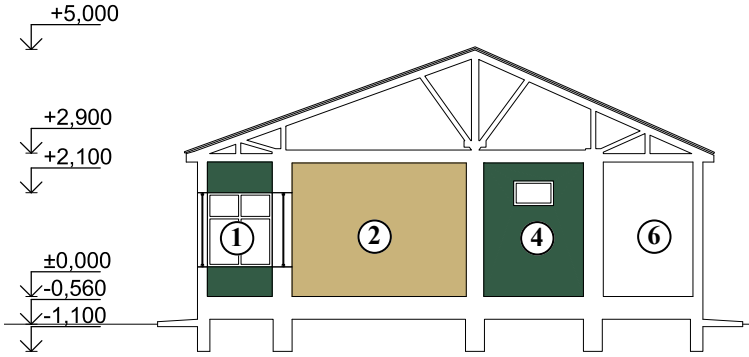

① Vestibule
8 m²

② First room
17 m²

③ Guest room
17,5 m²

④ Bathroom
5,1 m²

⑤ Kitchen
10 m²

⑥ Storage
17,3 m²



Part of the construction	Total Volume	Estimated cost of materials	Cost for 1m ² of construction
Rubble-concrete foundation	19 м ³	2 600	74,6
Walls (mudbricks)	47м ³	5 323	25
Wooden ceiling	4,13м ³	6 822	70
Wall insulation with mineral wool	95 м ²	6 748	68
Ceiling insulation with reeds	80 м ²	2 989	15
Reeds	128 м ²	6 912	54
Mud floor	34,5 м ²	2 415	70
Windows	5,1м ²	2 495	420
Doors	12,2 м ²	3 050	250
Antiseismic measures	Общая площадь	3 747	90
Other	Общая площадь	10599	132
Total		53 700*	
Transportation and labour		21 300	
TOTAL COST OF THE HOUSE		75 000 TJS	

**Prices of construction materials may vary depending on the market price*



VARIANTS



Variant B-2

A veranda replaces the tambur at the south facade. This option accommodates space for a tapchan but slightly limits direct gains through the house.



Variant B-3

The kitchen/bathroom block is located between the two rooms, all of which are linked by an internal corridor.



Variant B-4

The kitchen junctions the storage (saray) at the north facade and the veranda at the south.



South facade



North facade



Front view

Total estimated cost of the house | 53535 TJS

Total area | 46 m² - Heated spaces | 35 m²

Cost for 1 m² - 1150 TJS

Energy consumption | 43 kWh/m² * year (Class B)

460 kg of coal / winter (fully heated house)

Total saved compared to a non-insulated house -560 TJS/

In this proposed design, the use of solar energy is optimized in order to heat the rooms during the winter. In order to reduce the air infiltration through the door, there is a glazed veranda.

During the day, the veranda is heated by the sun and opening the doors of the inside rooms will allow heated air flows to provide additional heat. It can also be used as an additional space during the day.

A roof overhang will also allow to provide protection against overheating during the summer

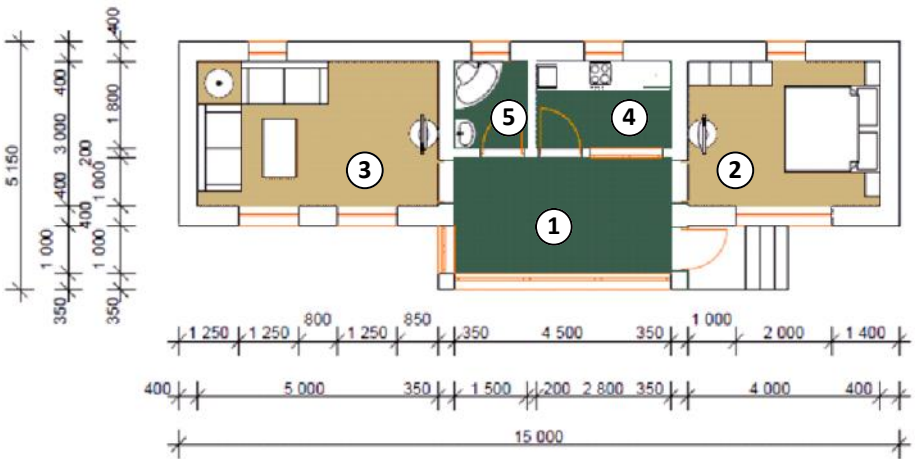

① Veranda
8 m²

③ Guest room
17,5 m²

⑤ Bathroom
2,7 m²

② First room
12 m²

④ Kitchen
5,1 m²



Part of the construction	Total Volume	Estimated cost of materials	Cost for 1m ² of construction
Rubble-concrete foundation	22 m ³	1 641	74.6
Walls (mudbricks)	31 m ³	775	25
Wooden ceiling	46 m ²	3 220	70
Wall insulation with mineral wool	85 m ²	5 780	68
Ceiling insulation with reeds	63 m ²	945	15
Reeds	107 m ²	5 778	54
Mud floor	46 m ²	3 220	70
Windows	24 m ²	10 080	420
Doors	10 m ²	2 500	250
Antiseismic measures	-	4 140	90
Other	-	10 000	158
Total		48 079*	
Transportation and labour		15 456	
TOTAL COST OF THE HOUSE		63 535 TJS	

**Prices of construction materials may vary depending on the market price*

VARIANTS

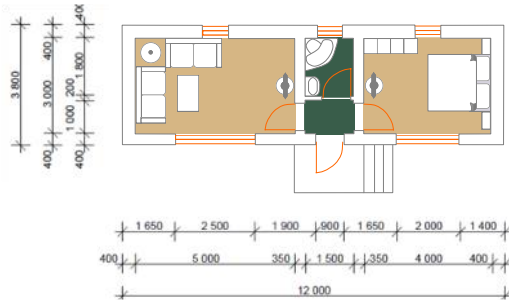

Variant C-2

This variant differs from the variant C-1, because there is no veranda or kitchen, but a porch and a small corridor

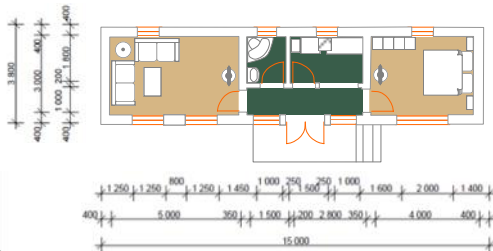

Variant C-3

In this variant, instead of the corridor there is a veranda and the living roommand instead of a single large window there are two smaller windows.

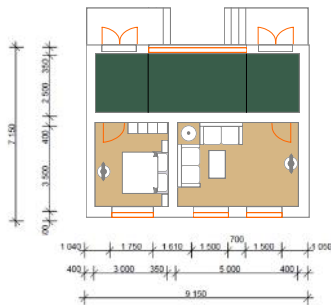

Variant C-4

Here, the entrance is on the northern side across the veranda. The veranda acts as a buffer zone. There is no bathroom nor kitchen. The two living rooms are not connected.



Variant C-5

A variant with three rooms. The entrance to the two rooms is across a corridor and the guest room is separated. The bathroom is linked with a dressing.



Energy Information Center

Are you planning to build a house?

Call us: **98 700 52 52**

Visit us: 34 Huseinzoda, Dushanbe

Website: www.infoenergy.tj



*Free consultation and advice from specialised experts
on energy efficient construction!*

This practical guide
«HOW TO BUILD AN ENERGY EFFICIENT HOUSE?»
is proposed by:



Group for Environment, Renewable
Energies and Solidarity

Authors:

Mirzokurbon Pochoev, Energy Specialist

Faridun Bazarov, Energy-efficiency Technical Advisor

With the participation of:

Armand Blondeau, Project Manager

Constant Janner, Architect

Design:

Alisher Makhmadaminov

With the technical support of:



SRICA—Scientific Research Insti-
tute for Construction
and Architecture



Tajik Technical University

And the financial support of:



AGENCE FRANÇAISE
DE DÉVELOPPEMENT
AFD—French Agency
for Development



Abbé Pierre Foundation



Organisation for Security and
Cooperation in Europe



GERES - TAJIKISTAN

Address: Ak. Rajabov 7, Dushanbe, Tajikistan

Tel: (+992) 98 700 52 52

E-mail: tajikistan@geres.eu

Web: www.geres.eu

December 2016

